

Varenummer: 203180M16100C3V

Beskrivelse: E+G Justerfod
GN 31-80-M16-100-C3-V

Note: V Uden møtrik, udvendig sekskant i toppen, spændeflade i bunden

Mål

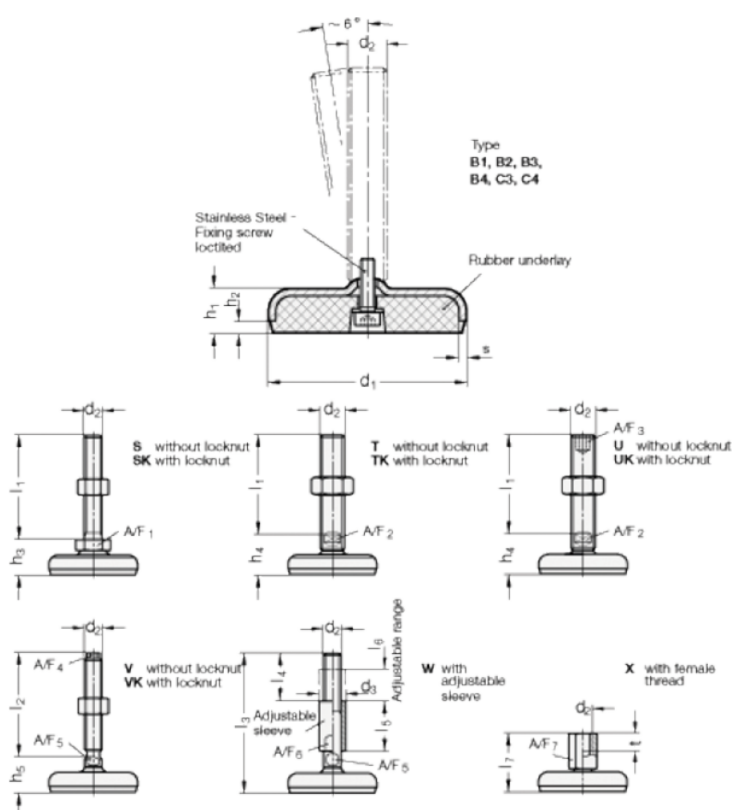

A/F4	= 10
A/F5	= 12
d1	= 80
d2	= 16
h1	= 18
h2	= 5
h5 +4.0/0	= 29
l2	= 100

s = 3